

HANOVER®

Hanover Outdoor Furniture



IMPORTANT

If you have any problems with this product (missing or damaged parts, assembly issues, etc.),

PLEASE DO NOT RETURN TO THE RETAILER/STORE

from where you purchased the product.

Please call our Toll-Free Customer Service Hotline at: **1-800-416-3511**

Between 9:00 AM and 5:00 PM Eastern Time, Monday through Friday

Or visit our website at: **www.hanover-products.com**

To expedite any future warranty claims, please retain the Instruction Sheet, Warranty Card and receipt for future use.

For additional on-line support on assembly, troubleshooting and care & maintenance of your outdoor furniture, please visit our website at: **www.hanover-products.com**.

ASSEMBLY INSTRUCTIONS

1

Attach the bottom panel to the back panel by using two 1/4"x35 mm bolts and washers as shown in *Figure 1*. Guide the bolts through holes in the bottom panel into the pre-drilled holes in the back panel. **Hand tighten only.**

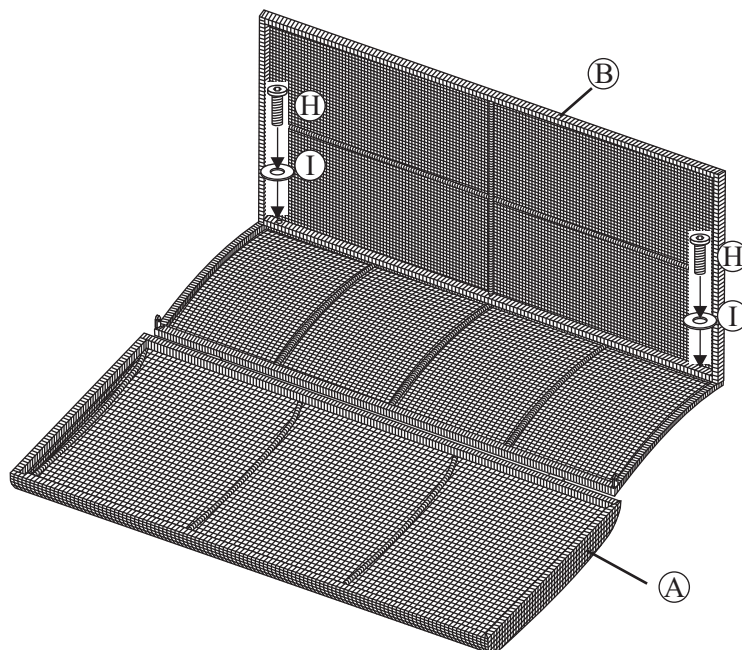

2

Attach the side panel-1 to the back panel by using a 1/4"x35 mm bolt and washer as shown in *Figure 2*. **Hand tighten only.** Attach the side panel-1 to bottom panel by using a 1/4"x20 mm bolt and washer as shown in *Figure 2*. **Hand tighten only.** Repeat this process for the side panel-2.

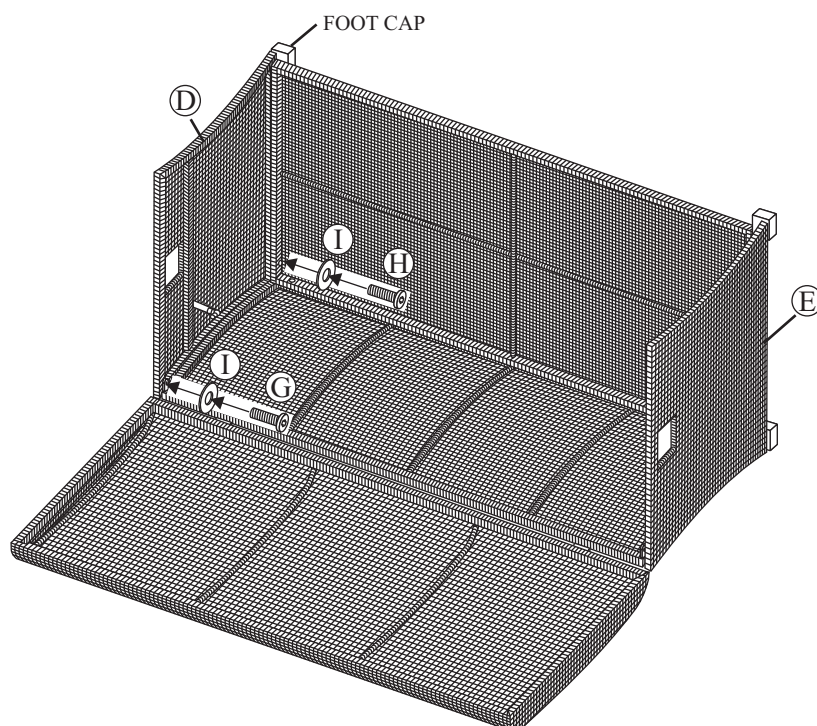

ASSEMBLY INSTRUCTIONS

3

Attach the front panel to the bottom panel by using four 1/4"x35 mm bolts and washers as shown in *Figure 3*. **Hand tighten only.** Attach the front panel to the side panels by using two 1/4"x20 mm bolts and washers as shown in *Figure 3*. **Hand tighten only.**

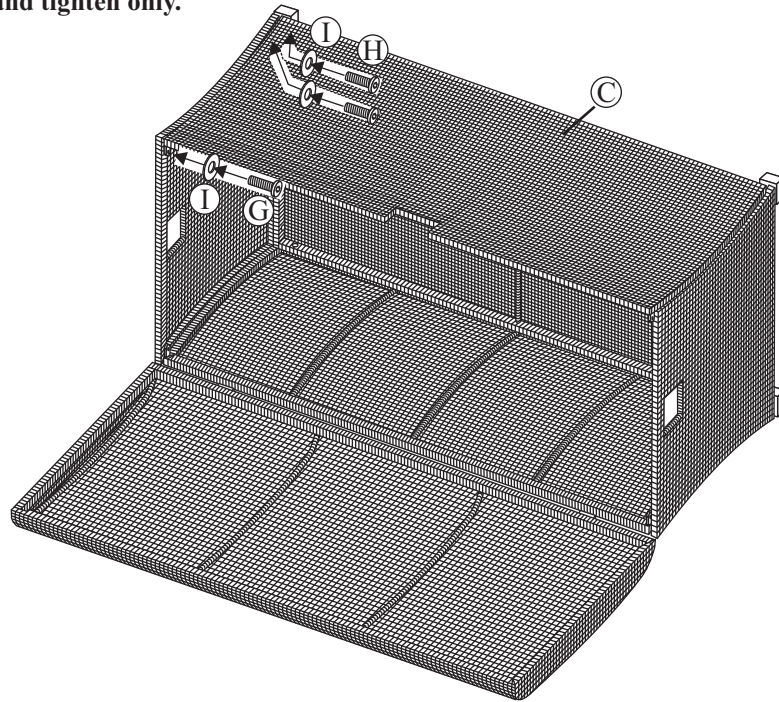

4

Attach a hydraulic lid support to the top panel with side panel as shown in *Figure 4*. **Hand tighten only.** Repeat for other hydraulic lid support.

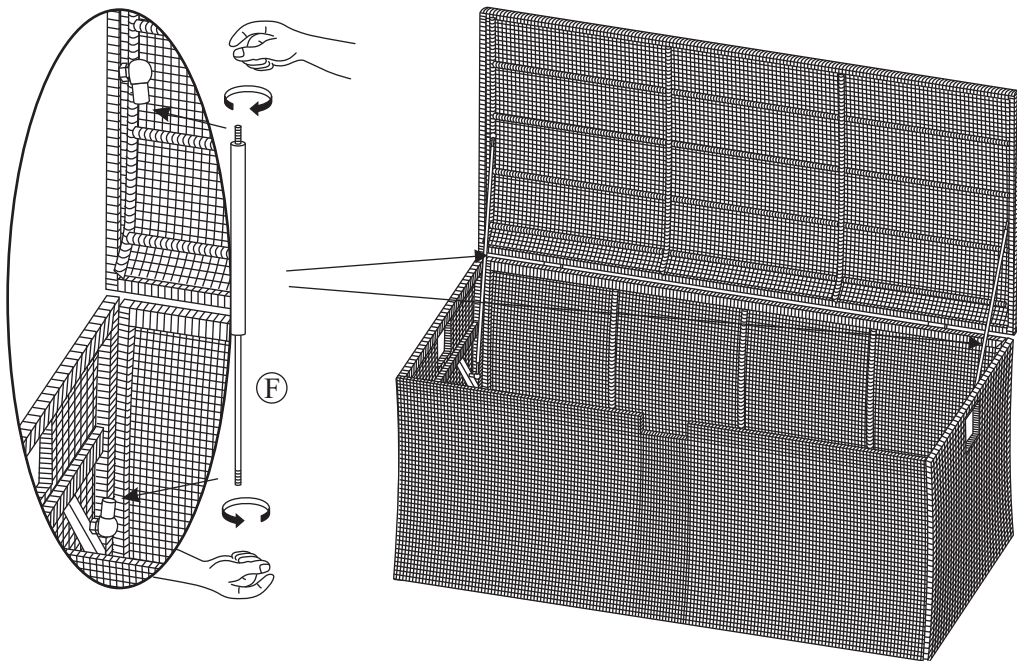











5

After making any necessary adjustments to the alignment of the all parts, use the hex bolt driver to tighten all bolts. **Note:** each bolt must be tightened a few revolutions at a time. In order to apply equal pressure to all bolt joints, we recommend working in a cross corner (X) fashion. Repeat until all bolts are tight. **Do not over tighten.** Over tightening may strip bolts.

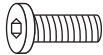
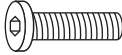
PARTS IDENTIFICATION LIST

* NOTE: PARTS SHOWN ON PARTS LIST ARE NOT TO SCALE

	<u>PARTS LIST</u>	<u>DESCRIPTION</u>	<u>ORDER PART #</u>	<u>QTY</u>
A		TOP PANEL WITH BACK PANEL	SA0570	1
B		BOTTOM PANEL	SA0571	1
C		FRONT PANEL	SA0572	1
D		SIDE PANEL-1	SA0573	1
E		SIDE PANEL-2	SA0574	1
F		HYDROLIC LID SUPPORT	SA0575	2
G		1/4" X 20 MM BOLT	HW0036	4
H		1/4" X 35 MM BOLT	HW0142	8
I		Ø6.5 X 1.0 MM WASHER	HW0004	12
J		HEX BOLT DRIVER	HW0006	1
		FOOT CAP FACTORY ASSEMBLY	FC0030	