

INSTRUCTION MANUAL

WINE COOLER / BEVERAGE COOLER

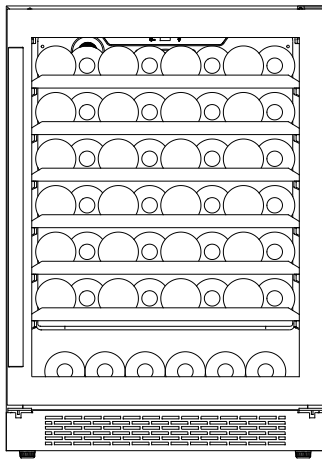

Wine Cooler - Model 9760301

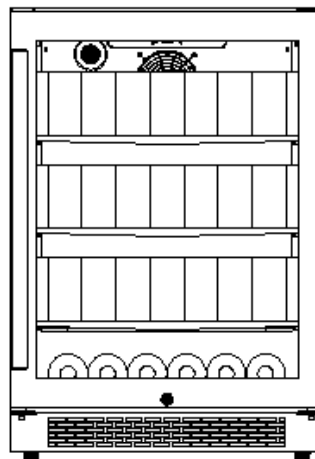

Beverage Cooler – Model 9760101
9760201



To ensure proper use of this appliance and your safety, please read the following instructions completely before operating this appliance.

V20190515

WARNING!

- To prevent damage to the door gasket, make sure to have the door fully open when sliding shelves out.
- The appliance must be positioned so that the plug is accessible at all times.
- This item should be plugged into a power outlet directly. Do not plug into an extension cord or power strip.
- Do not move your wine cooler/beverage cooler when filled with wine or beverages as this might distort the body.
- Do not touch the compressor on the wine cooler/beverage cooler.
- The assembly of this appliance should be done with caution as there are hazards involved. Children should not play with the appliance.
- If the electric cord or plug is damaged, it must be replaced by the manufacturer or a similarly qualified person in order to avoid a hazard.
- This appliance should only be used by people 8 years and older. Persons with reduced physical, sensory and mental capabilities or lack of experience and knowledge must have supervision or instruction concerning use of the appliance in a safe way and understand the hazards involved. Children should not play, perform maintenance, or clean the appliance.

IMPORTANT SAFETY INSTRUCTIONS

WARNING

Follow these basic steps to reduce the risk of fire, electrical shock, or injury.

- Save these instructions for future use.
- **DANGER WARNING:** Risk of child entrapment. These appliances carry a risk of child entrapment and suffocation. Junked or abandoned appliances are still dangerous even if they are not in use.
- Never allow children to play or crawl inside the appliance.
- Before disposing of your old wine cooler/beverage cooler, take off the door and leave the shelves in place so that children are not able to climb inside. Failure to do so can create a significant hazard.
- Make sure the appliance has an open ventilation system and is clear of obstruction.
- Never clean appliance parts with flammable fluids. The fumes can create a fire hazard or explosion.
- Do not store or use gasoline or any other flammable vapors and liquids in the vicinity of this appliance. The fumes can create a fire hazard or explosion. Do not store explosive substances such as aerosol cans with a flammable propellant in or around this appliance.
- **WARNING:** keep the ventilation openings in the appliance enclosure/ cabinet or in the built-in structure clear of obstructions.
- **WARNING:** Do not use mechanical devices or other means to accelerate the defrosting process.
- **WARNING:** Do not damage the refrigerant circuit.
- **WARNING:** Do not use electrical appliances inside the food storage compartments of the appliance, unless they are the type recommended by the manufacturer.
- **WARNING:** Always install the appliance on a stable surface to avoid any hazard.
- The only refrigerant that should be used is R600a. Flammable and explosive articles should not be put in or near the appliance to avoid a fire or explosion.

INSTALLATION INSTRUCTIONS

Before Using Your Wine Cooler/Beverage Cooler:

- Remove the exterior and interior packing.
- Before connecting the wine cooler/beverage cooler to the power source, let it stand upright for approximately 2 hours. This will reduce the possibility of a malfunction in the cooling system from handling during transportation.
- Clean the interior surface using a soft cloth and a lukewarm water mixture of 2 tablespoons of baking soda for each quart of lukewarm water.
- This appliance is intended to be used for residential applications
- When disposing your appliance, please choose an authorized disposal site.

Installation of Your Wine Cooler/beverage cooler:

- This appliance is designed to be installed under the counter or built in to a cabinet.
- This appliance is intended to be used exclusively for the storage of wine and beverages.
- Place your wine cooler/beverage cooler on a level surface that is strong enough to support the weight when fully loaded.
- This appliance is using flammable refrigerant. Be careful not to damage the cooling pipe during the transportation.
- Place the wine cooler/beverage cooler away from direct sunlight and sources of heat (stove, heater, radiator, etc.).
- Direct sunlight may affect the acrylic coating and heat sources may increase electrical consumption. Extreme cold ambient temperatures may also cause the unit to not perform properly.
- Avoid locating the unit in humid areas.
- Plug the wine cooler/beverage cooler into a properly installed-grounded wall outlet. Do not under any circumstances cut or remove the third (ground) prong from the power cord. If you have any questions concerning power and/or grounding please contact a certified electrician or an authorized product service center.

CAUTION:

- Do not overload the wine cooler/beverage cooler.
- Do not cover shelves with aluminum foil or any other shelf material which may prevent air circulation.
- To store the wine cooler/beverage cooler for an extended period of time; the unit should have a thorough cleaning and the door should be left ajar to allow air to circulate. This will avoid the possible formation of condensation, mold or odors.

Ambient Room Temperature Limits

This appliance is designed to operate in ambient temperatures between 60° F and 109°F (between 16°C and 43°C).

Installation clearance requirements

When installing the beverage center under a counter, follow the recommended spacing dimensions.

To ensure proper service access and ventilation, the product must have at least 2 inches clearance in the back, 3/8" at top and 3/8" at sides. The installation should allow the unit to be pulled forward for servicing if necessary.

Do not install the wine cooler/beverage cooler near an oven, radiator, or other heat source.

It is not recommended to install the appliance in a corner or flush against a wall. The door needs to open more than 90° to allow full extension of the shelves. Leave at least 2-4 inches (5-10 cm) of space between the wall and the appliance to allow for the door opening when it is necessary to place the unit next to a wall or in a corner.

Built in cabinetry dimensions must be at least 24.6 inches (62.5cm) wide by 35 inches (88.9 cm) high by 25 inches (63.5 cm) deep.

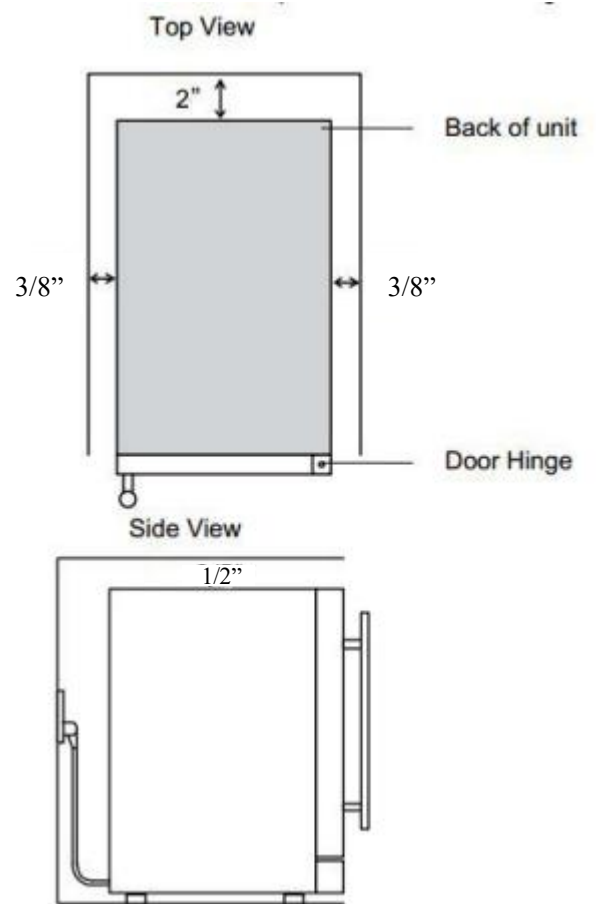
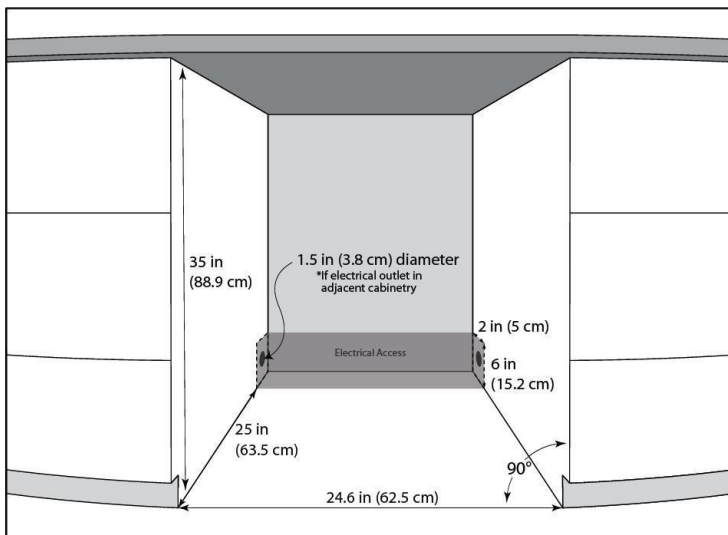

Handle installation

- Open the door and carefully pull back the door gasket in the areas where the handle screws are placed.
- Align the handle with the screws and tighten using a screwdriver until the handle is flush against the doorframe. To insure a proper fit, alternate tightening of the screws before completely tightening either screw.
- Carefully press the door gasket into its original position.

CAUTION: Do not over-tighten the screws as this may cause damage to the handle or to the stainless steel door.

Reversing the door

- A. Open the door to a 90degree angle, take out the 2 screws from the lower door axis (1) remove the door (2) and the axis plate from the door.
- B. Take out the 3 hinge screws from the top right hinge (3) and remove it.
- C. Remove the decorative covers (5) from the top left of the cabinet and install the new top hinge (4) at top of the cabinet with 3 screws.
- D. Place the decorative covers over the right hinge.
- E. Install the door once correctly aligned.

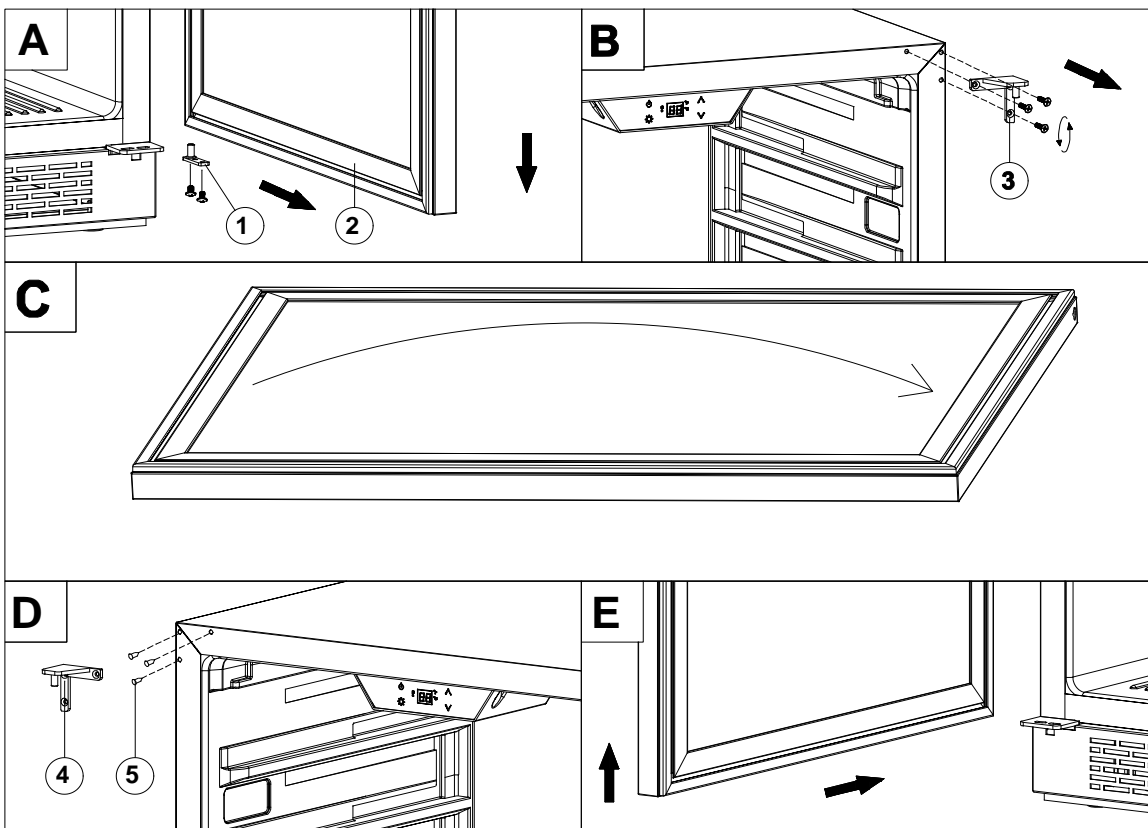





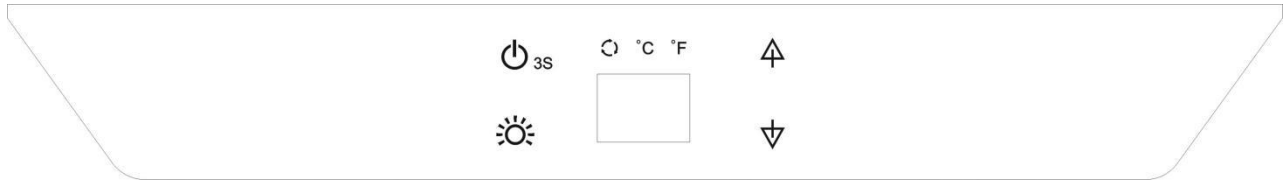

Unit Operation

Before plugging in the product for the first time, remove all packaging, let product stand upright for at least 2 hours and clean the cooler with a soft rag and the cleaning mixture. Wipe dry with soft clean cloth.

Control Panel



Beverage center has a temperature range of 34°F to 50°F. Wine cooler has a temperature range of 34°F to 64°F.

- **Power Button**  _{3S} : Turns the unit on and off. (Press and hold this button for approximately 3 seconds.)
- **Light Button**  : Turns the interior light on/off .
- **Up Button**  : Used to raise (warm) the temperature by one degree.
- **Down Button**  : Used to lower (cool) the temperature by one degree.
- **Indicator light**  : Compressor in operation display.
- To switch the display between the Fahrenheit (°F) and Celsius (°C) scale, press the ‘  ’ and ‘  ’ Button simultaneously for approximately five (5) seconds.

Temperature Recollection Function

In the event of a power interruption, the cooler will remember the temperature settings. When power returns, it will go back to the same temperature setting as before the power went off.

Temperature Alarm

When interior temperature is higher than 73°F (23C) “HI” shows on display panel and the buzzer alarm rings for one hour continuously. Please check the reason.

When interior temperature is lower than 28°F (-2C) “LO/CL” shows on display panel, and the buzzer alarm and the malfunction indicator light up at the same time.

Shelf Installation or Removal

To prevent damage to the doors or gasket seals, open the doors completely (past 90°) when removing the shelves. When removing any of these shelves out of the unit, you must lift (from the rear) and pull it towards you. To re-install, ensure the shelf is resting securely on the support brackets and push shelf inward until it locks into place.

CAUTION: Do not cover the gap of glass shelves with aluminum foil or any other material that will prevent adequate air circulation within the cabinet.

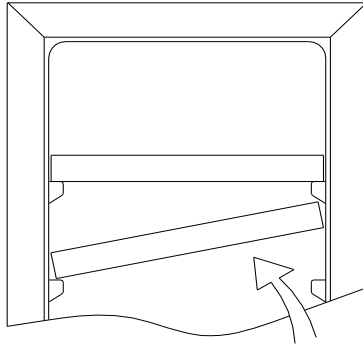

Using Lock (Select Models Only)

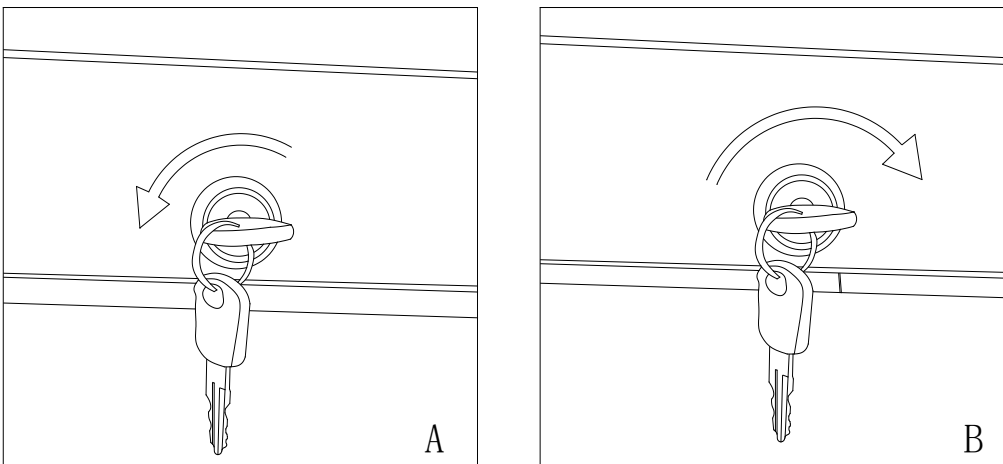

- To lock the unit; ensure key is inserted into the keyhole. Turn the key in the arrow direction (counterclockwise) shown in Figure A then the wine cabinet is locked.
- To unlock the unit: ensure key is inserted into the keyhole. Turn the key in the arrow direction (clockwise) shown in Figure B then the wine cabinet is unlocked.

Wine Cooler Storage – 54 bottle maximum:

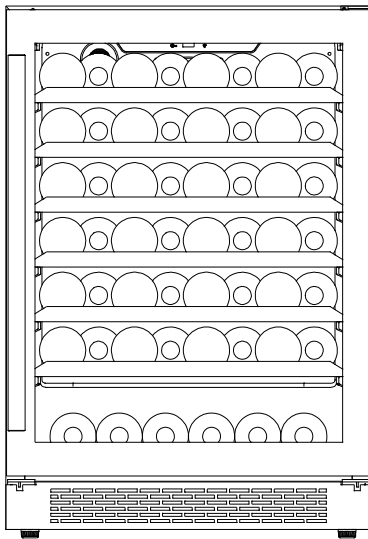

Wine Shelf Top

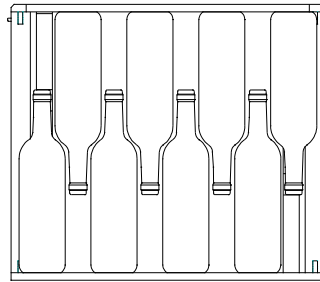

Beverage Cooler Storage – 172 can maximum:

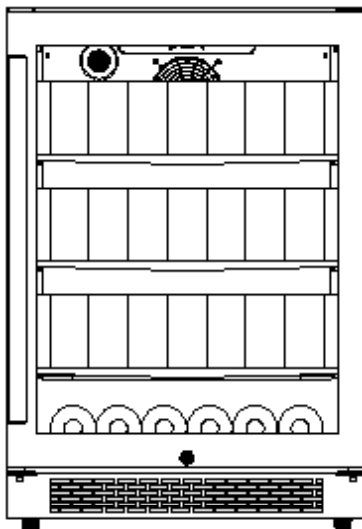

Beverage Shelf Top View

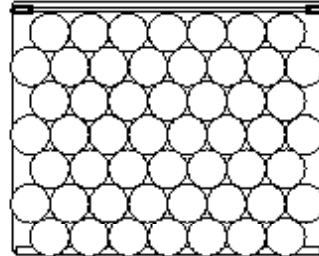

Cleaning your cooler

Always unplug your unit before cleaning or servicing it. You may want to defrost the cooler at this time. If so, follow the instructions below. To clean the cooler, use a soft rag and a mixture of lukewarm water and baking soda (2 tablespoons baking soda in 1 quart of water works well). Clean the cooler and then dry it with a soft clean cloth.

Defrosting

Note that depending on the refrigeration settings, the unit will automatically defrost under most ambient conditions. However, on colder settings, some frost may build up. Additionally, the more humid the ambient conditions, the more frost may build up. To minimize frost build up, keep the door closed as much as possible.

If you experience frost build up, defrost the unit:

- Unplug the unit and empty all of the contents
- Prop open the door 3” or more
- Allow the frost to melt (Do not chip away the ice). Use a towel to collect the water.
- When the frost is completely melted, clean the unit and let dry
- When the unit is dry, reconnect power, turn unit on and replace all of the contents

Troubleshooting

The cooler is not working:

- Check that the plug is inserted correctly into the wall socket.
- Check that there is power to the wall socket by plugging in another appliance.
- Check the fuse.

The cooler is noisy when running:

- Check to make sure that the cooler is level and it is not in contact with another appliance or furniture.
- Note: a gentle trickling sound is normal; this is likely coolant in the sealed system or condensate water from the unit.

The cooler does not cool sufficiently:

- If the door has been opened too often, or it has been left open for a while it will take time for the cooler to reach its set temperature.
- Check that the airflow from the rear of the cooler has not been reduced or obstructed due to insufficient clearance.

Storage

If the cooler is not in use for a long period of time, it should be cleaned and stored. Disconnect power from the unit. Defrost, clean and dry the inside. Leave the door open to prevent any moisture build up while the cooler is not in use.

CAUTION: Store the unit in a way so that children will not play with it and do not attempt to hide inside the unit. Do not store the unit with the shelves removed.